



TechBook

in.temp

A new way to regulate the water of your spa



Plug and play solution

Benefit from energy savings

A total flexibility that can also
cool down water





Table of contents

Safety instructions	2
Warnings	3
Introduction	5
Overview	7
- in.temp overview	7
- Box content	7
- in.temp dimensions	8
- Exploded view	8
Connections	9
Installation	10
Operating modes	12
Maintenance	13
Steps to winterize your in.temp	14
Troubleshooting	15
Specifications	16



Safety instructions



CAUTION
RISK OF ELECTRIC SHOCK
DO NOT OPEN



CAUTION: TO REDUCE THE RISK OF ELECTRIC SHOCK, DO NOT DISMANTLE THE UNIT. THERE ARE NO USER SERVICEABLE PART INSIDE. REFER SERVICING TO QUALIFIED SERVICE PERSONNEL.



The lightning flash with the arrowhead symbol within an equilateral triangle is intended to alert the user to the presence of uninsulated "dangerous voltage" within the product's enclosure that may be of sufficient magnitude to constitute a risk of electric shock to persons.



The exclamation point within an equilateral triangle is intended to alert the user to the presence of important operating and maintenance (servicing) instructions in the service literature accompanying this appliance.



IMPORTANT SAFETY INSTRUCTION:

For your own safety please read the following important safety instruction carefully before attempting to connect this unit to the main power supply. They will also allow you to get the best performance and prolong the life of the unit.

* READ THESE INSTRUCTIONS.

* KEEP THESE INSTRUCTIONS.

* HEED ALL WARNINGS.

* FOLLOW ALL INSTRUCTIONS.

* CLEAN ONLY WITH DRY CLOTH. BEWARE THE APPLICATION OF SOME PRODUCTS COMMONLY USED AGAINST CORROSION (SUCH AS WD-40 FAMILY PRODUCTS) AS THEY COULD DAMAGE THE ENCLOSURE, DUE TO A NEGATIVE CHEMICAL REACTION BETWEEN SOME INDUSTRIAL OILS AND ITS PLASTIC ENCLOSURE. ANY OTHER MATERIALS WHICH MAY COME IN CONTACT WITH THE ENCLOSURE MUST BE CAREFULLY EVALUATED UNDER END USE CONDITIONS FOR COMPATIBILITY.

* DO NOT INSTALL NEAR ANY HEAT SOURCES. CLEARANCE AND MINIMUM DISTANCE BETWEEN THE VARIOUS PARTS OF THE APPLIANCE AND THE SURROUNDING STRUCTURE ARE NOT SPECIFIED AS LONG AS THEY ARE SUFFICIENT SO THAT THE AMBIENT TEMPERATURE AROUND THE APPARATUS DOES NOT EXCEED 140°F (60°C).

* ONLY USE ATTACHMENTS/ACCESSORIES SPECIFIED BY THE MANUFACTURER.

* REFER ALL SERVICING TO QUALIFIED SERVICE PERSONNEL. SERVICING IS REQUIRED WHEN THE APPARATUS HAS BEEN DAMAGED IN ANY WAY, SUCH AS POWER-SUPPLY CORD OR PLUG IS DAMAGED, LIQUID HAS BEEN SPILLED OR OBJECTS HAVE FALLEN INTO THE APPARATUS, DOES NOT OPERATE NORMALLY, OR HAS BEEN DROPPED.

Gecko®, and their respective logos are Registered Trademarks of Gecko Alliance Group.
in.temp™, in.grid™, in.ye™, in.yt™, in.yj™, in.k1000™, in.clear™, in.touch 2™, in.k110™ and their respective logos are Trademarks of Gecko Alliance Group.

All other product or company names that may be mentioned in this publication are tradenames, trademarks or registered trademarks of their respective owners.



Warnings



WARNINGS:

Before installing or connecting the unit, please read the following

- * DO NOT DISASSEMBLE OR ALTER THE APPARATUS
- * DO NOT USE FOAM TO ISOLATE THE UNIT
- * TURN POWER OFF BEFORE MODIFYING ANY CABLE CONNECTION IN THIS UNIT
- * TURN POWER OFF BEFORE CLEANING OR SERVICING THIS UNIT
- * PRODUCT MUST BE DISPOSED OF SEPARATELY FROM NORMAL HOUSEHOLD IN ACCORDANCE WITH LOCAL WASTE DISPOSAL LEGISLATION
- * DO NOT SERVICE THIS PRODUCT YOURSELF





in.temp

A new way to regulate the water of your spa

Here comes Gecko's new heat pump solution. Using our in.temp has never been so easy ! Simply connect it to a Y series control that supports it and you're good to go ! Automatic detection, smart power management and no additional power circuit required, the in.temp powers directly from the spa control.

Are you looking for the most energy efficient form of heating water? Our in.temp is the perfect solution ! Air sourced heat pumps will allow you to save up to 75% energy consumption in comparison with electric elements. The icing on the cake: Gecko's in.temp also uses an ecofriendly refrigerant.

With in.temp, you can choose one of its six modes of operation that suits you the best, depending on your climate. Smart modes let you taking full advantage of your in.temp to optimize your savings.



Introduction

This document

This document includes the necessary information to safely install and maintain your in.temp. Please read this manual carefully before you operate the unit.

The in.temp

The in.temp is one of the most economical ways of heating your spa efficiently. Using the free renewable energy from the air, it is over 4/5 time more efficient than traditional heating. The in.temp gives you comfort at high level so you can enjoy your spa not only in summer, but also in spring, fall and even winter time.

ECO Friendly

The in.temp uses a refrigerant which is ozone friendly and dramatically reduces Carbon Emissions.

Titanium heat exchanger

The advanced titanium heat exchanger guarantees a longer life span, free of corrosion. It can be used with all types of water treatment including chlorine, iodine, bromine and salt water.

Multiple functions

- Cooling and heating functions available
- Auto operation, Auto-restart, Auto defrost
- No human attendance is required
- Wide ambient working range: -5°C to 43°C

Reliable operation

The in.temp has several built in safety features, which include insufficient water flow protection, high/low pressure protection, overload protection, compressor protection.

Self-diagnosis

When there is malfunction, the in.temp will make self-diagnosis by displaying an error code on the spa keypad. To identify the problem, please refer to ERROR CODES pages in this manual.



Overview

in.temp overview



Model	Part #
IN.TEMP-H5.0-CE	0615-807002
IN.TEMP-H7.5-CE	0615-807003
IN.TEMP-H5.0	0615-807000
IN.TEMP-H7.5	0615-807001

Box content - CE Model

- in.temp
- Quick Reference Card - 9919-101638
- Accessory kit
- 9920-401527 Heat pump communication cable 5 meter (16 feet) - pre-installed
- 9920-401529 Heat pump power cord euro 14/3 AWG 5 meter (16 feet) - pre-installed

Optional / sold separately

- 9920-401528 Heat pump communication cable 10 meter (33 feet)
- 9920-401530 Heat pump power cord euro 14/3 AWG 10 meter (33 feet)

Box content - NA* Model

- in.temp
- Quick Reference Card - 9919-101638
- Accessory kit
- 9920-401527 Heat pump communication cable 5 meter (16 feet) - pre-installed
- 9920-401532 Heat pump power cord n-a 14/3 awg 5 meter (16 feet) - pre-installed

Optional / sold separately

- 9920-401528 Heat pump communication cable 10 meter (33 feet)
- 9920-401531 Heat pump power cord n-a 14/3 awg 10 meter (33 feet)

*North American



Overview

in.temp dimensions

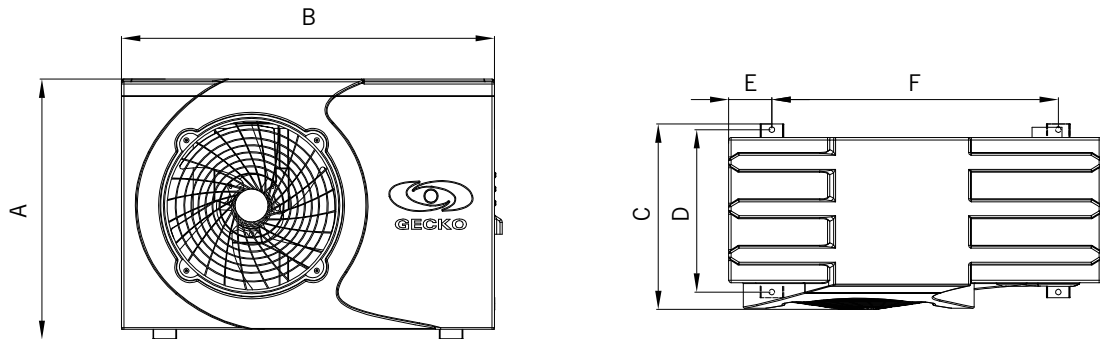

	Gecko-5kW	Gecko-7.5kW
A	555 mm (21,85 in)	661 mm (26,02 in)
B	794 mm (31,26 in)	902 mm (35,51 in)
C	395 mm (15,55 in)	423 mm (16,65 in)
D	346 mm (13,62 in)	356 mm (14,02 in)
E	92 mm (3,62 in)	141 mm (5,55 in)
F	610 mm (24,02 in)	620 mm (24,41 in)
G	260 mm (10,24 in)	370 mm (14,57 in)
H	96 mm (3,78 in)	96 mm (3,78 in)

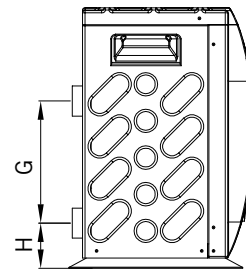

Exploded view

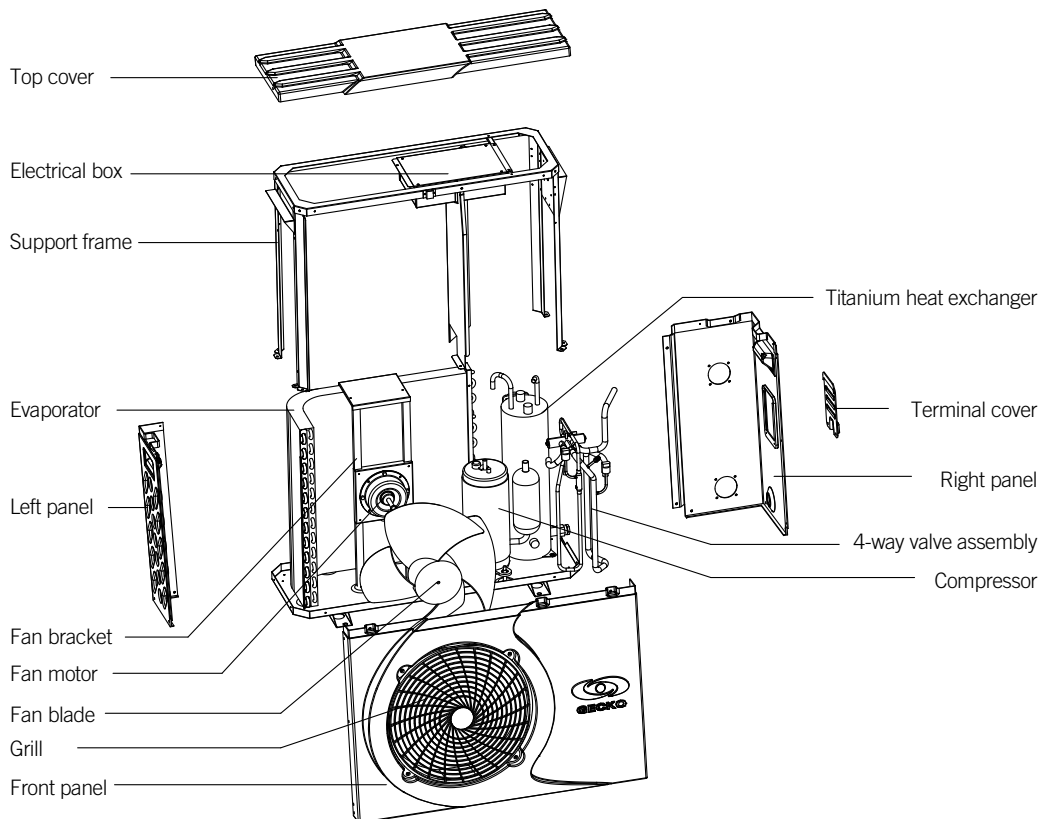



Connections



Turn off power before connecting the in.temp to the spa control system.

System connection

The communication cable provided with the heat pump must be connected to the RS485 communication port of the spa control.

The power cable connects to the spa control using 6,35mm (0,250") quick connect female terminals. Ensure that all female terminals are correctly and completely seated on the printed circuit terminals for proper current ratings.

The connection must be done according to the following tables:

CE Model			NA* Model		
Brown	Main line P28, P30 or P32 tab (F2)		Black	Main line P31, P33 or P36 tab (F3)	
Blue	Any Neutral (N) tab		White	Any Line 2 (L2) tab	
Green/Yellow	Any Ground (G) tab		Green	Any Ground (G) tab	

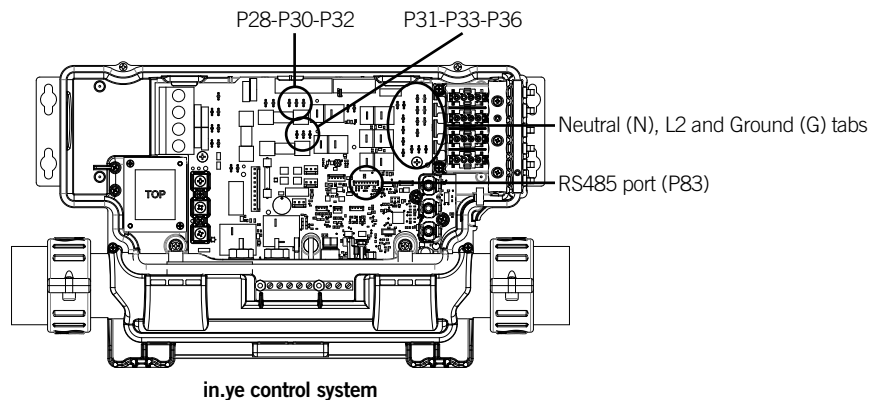

Terminal box

The terminal box is located behind the terminal cover and allows access to the communication and power connections.

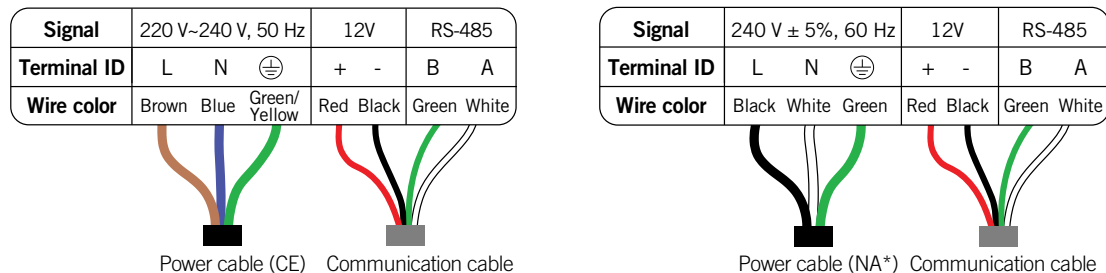

External breaker

The in.temp is intended to be powered by the spa control using the included power cable but it can also be powered by an external circuit breaker.

If an external circuit breaker is used to power the in.temp, make sure the cord used comply with all local regulation.

To avoid unnecessary shedding of accessories when the in.temp or a different heat pump is not powered by the spa control, set the heat pump current to zero (0) through your spa user interface.

*North American



Installation



CAUTION

Do not install the unit in a place where flammable gas leak can occur.

All plumbing connections should be carried out as per the instructions in this manual. Failure to do so could result in water damage to property.

Avoid contact with the fan when the unit is operating as this will cause serious injury.

Ensure the in.temp is correctly grounded to earth with the power cable.

Locating the in.temp



The in.temp should NOT be installed in an airtight location or confined space, such as a basement or garage. The in.temp requires good air ventilation. It will discharge cold air when it is heating and hot air when it is cooling, and its efficiency depends on its ability to draw normal ambient temperature air and discharge the cold or hot air well away from the unit. It is recommended to install the in.temp away from any other home appliances, to avoid the chance of electromagnetic interference. Please refer to the "Air space requirements" section of this manual.

The unit should be located on a solid flat surface with a slight rearward slope. Ensure 3 meters (9 feet) of free air flow to the discharge panel and 1 meter (3 feet) to the inlet panel as well as free airflow to all sides of the unit. Ensure adequate access for maintenance purposes.

In cold climates, the in.temp should be installed at least 46 cm (18") above the ground level on an open metal frame in order to prevent the accumulation of ice at the base of the unit caused by condensation. Your in.temp specialist may recommend a dedicated frame rusted proof. See also recommendations in the Condensation section further.

Air space requirements

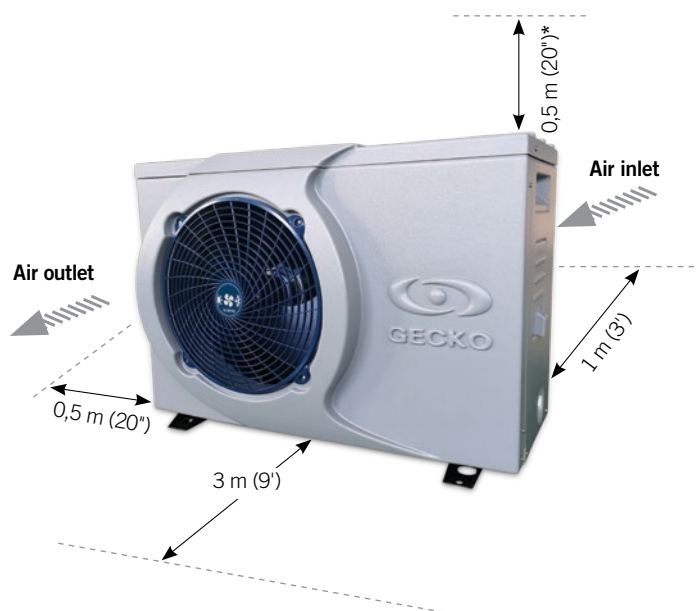

* Top clearance is only a recommendation to ease service.



Installation

Precautions

- Avoid locating the unit close to bedrooms or other noise sensitive areas.
- Avoid a location which could create vibration (e.g. secured to a solid wall).
- The fan should not blow towards windows, walls or spaces likely to be inhabited by people or animals.
- Do not install where the in.temp is likely to be subjected to polluted air, dust or debris, etc.
- Avoid directing fan output against the dominant wind directions.
- Protect the heat pump from possible snow fall.
- Minimise exposure to environmental conditions as much as possible and never block the airflow.

Securing the in.temp

The in.temp should be securely fixed. The four included rubber mounts should be installed to absorb high-frequency vibrations.

Piping

A bypass, consisting of three valves, must be installed to adjust water flow to the in.temp and to isolate the apparatus for maintenance purpose.

For a more stable flow in the heat exchanger, it is recommended to install the in.temp on the pressure side of the main pump.

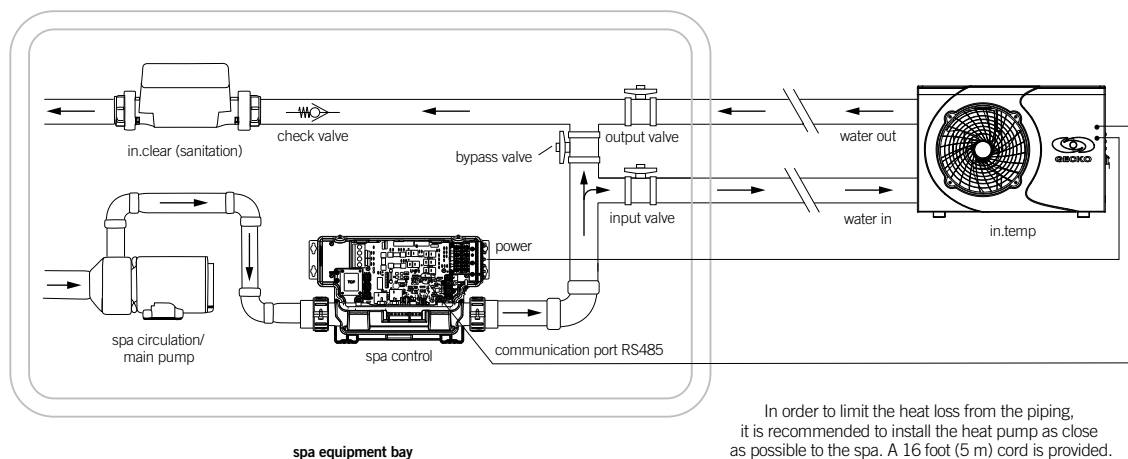

If your installation is equipped with a water treatment system (chlorine, bromine, salt, etc.) the bypass must be installed before the water treatment, with a check valve between the bypass and water treatment system.

Condensation

The air drawn into the in.temp is strongly cooled by the operation of the in.temp for heating the spa water, which may cause condensation on the fins of the evaporator. The amount of water may be as much as several liters per hour at high relative humidity. This is sometimes mistakenly regarded as a water leak.

Since water generated by condensation will be evacuated at the bottom of the in.temp, it is better to provide a slight rearward slope when installing the in.temp to allow this water to flow freely on the ground. It must also be ensured that this evacuation of water will not affect any components around the in.temp like electrical circuit and material like wood or metal that can be weakened by water. That said, be aware that water will flow under the in.temp in normal operation.



Operating modes

The operating mode can be changed through the spa user interface.

Six different operating modes are available:

- 1) Eco Heat (EcoH)
- 2) Smart Heat (HEAT)
- 3) Cool (COOL)
- 4) Eco Auto (AUTO)
- 5) Smart Auto (SMRT)
- 6) Electric (ELEC)

Eco Heat (EcoH)

In this mode, the in.temp is used as the unique source of heating. The heating element is kept off and the in.temp is not used to cool the water should its temperature rise above the current set point.

Smart Heat (HEAT)

This mode uses the in.temp as the main heating source. The heating element is turned on only if there is a large temperature difference between the water and the set point or if the ambient temperature gets too low. The in.temp is not used to cool the water in this mode.

Cool (COOL)

This mode uses the in.temp in cooling mode only. The in.temp is not used as a heating source and the heating element is never activated.

Freeze Protection

In cold weather, if it becomes impossible for the in.temp to keep the water temperature above freezing point, the help of the heating element might be required even if its use should be prohibited by the operating mode or conditions.

At any time, if the water temperature drops too close to the freezing point, the operating mode will be switched temporarily to “Smart Heat” and the system will heat until the minimum allowed set point has been reached before reverting to its previous operating mode and resume normal operation.

Three minutes waiting time

In any circumstances, when the in.temp is shut down, please be aware that there is forced waiting time of three minutes before the in.temp can operate again. This is so to prevent damage to the equipment. For example, if the operating mode has been changed from Cold to Hot succeeding an increase of the setpoint, the in.temp will be allowed to start only after a delay of three minutes.

Eco Auto (AUTO)

This mode borrows functionality from both Eco Heat and Cool modes and has the ability to select the proper Heat or Cool mode automatically according to the water temperature. The heating element is never activated in this mode.

Smart Auto (SMRT)

This mode borrows functionality from both Smart Heat and Cool modes and has the ability to select the proper Heat or Cool mode automatically according to the water temperature. The heating element is activated only if there is a large temperature difference between the water and the set point or if the ambient temperature gets too low.

Electric (ELEC)

This mode keeps the heat pump off and uses only the heating element to regulate water temperature.



Maintenance

To protect the paintwork, avoid leaning or putting objects on the shell. in.temp parts can be wiped with a damp cloth and domestic cleaner. (Warning: Never use cleaning agents containing sand, soda, acid or chloride as these can damage the surfaces.)

To prevent clogging in the titanium heat exchanger, ensure that the system incorporates a water and filter treatment equipment. In the event of a problem occurring due to contamination, the system should be cleaned as described below. (Warning: the fins on the finned tube heat exchanger are sharp!).

Cleaning the Heat Exchanger and Pipework

Contamination in the pipes and heat exchanger can reduce the performance of the in.temp. If this is the case, the pipe system and heat exchanger must be cleaned by a technician. Use only pressurized drinking water for cleaning.

Cleaning the air system

The finned heat exchanger, fan and condenser outflow should be clear of all obstructions (leaves, twigs, etc.) before each new heating season. These can be manually removed using compressed air or by flushing with clean water. It may be necessary to remove the unit cover and air inlet grid first.

Warning: Before opening the unit, ensure that all electrical supplies are protected from human access.

To prevent the evaporator and the condenser tray from being damaged, do not use hard or sharp objects for cleaning. Under extreme weather conditions (e.g. snow drifts), ice may form on the air intake and exhaust air outlet grids. If this happens, the ice must be removed in the vicinity of the air intake and exhaust air outlet grids to ensure that the minimum air flow rate is maintained.

Winter Shutdown

To prevent frost damage to the unit when not in use the in.temp should be drained of all water. If the in.temp cannot be winterized, another form of frost protection should be considered.

Warning: The warranty does not cover damage caused by inadequate frost protection measures during the winter.



Steps to winterize your in.temp

- Turn off all electrical power to the in.temp.
- Turn off the circulation pump.
- Disconnect the water piping inlet and outlet from the in.temp.
- Remove the drain plug and make sure the heat exchanger drains out.
- The in.temp should be blown out with air to ensure no water is left inside. A compressed airline should be placed into the water outlet line to blow air through the unit.
- Loosely reconnect the plumbing connection and drain plug to allow any remaining water to drain but block insects and debris.
- Cover the in.temp with a protective tarp to prevent snow and other debris from going in the fan grill.
- Finally, ensure that all plumbing going from the in.temp to the spa has been emptied from all water.



Troubleshooting

Error codes

If a protection kicks in or if an error is detected in the heat pump, an error code will be reported on the spa keypad. If more than one error is detected, only the error with the highest priority will be displayed.

All error codes are listed below in priority order.

Error code	Error description
HP99	Communication error
HP05	Coil temperature sensor failure
HP18	Water outlet temperature sensor failure
HP42	System 1 high pressure protection
HP46	System 1 low pressure protection
HP41	Water flow protection
HP01	System 1 exhaust temperature sensor failure
HP19	Water inlet temperature sensor failure
HP09	System 1 return gas temperature failure
HP22	Ambient temperature sensor failure
HP65	Ambient temperature too low protection
HP55	Water inlet/outlet temperature difference protection
HP51	System 1 exhaust temperature too high protection
HP63	Water outlet temperature too low protection when defrosting
HP56	Water outlet too cold for cooling



Specifications

Environmental ratings

Operating temperature: -5 °C (23 °F) to 43 °C (109 °F)

Water resistance: IPX4

Mechanical	CE models		NA* models	
Compressor:	Rotary (GMCC)		Rotary (GMCC)	
Pressure:	Min: 1,5 MPa (218 psi) Max: 4,15 MPa (609 psi)		Min: 1,5 MPa (218 psi) Max: 4,15 MPa (602 psi)	
	5kW	7,5kW	5kW	7,5kW
Refrigerant:	R32/650g (22,9oz)	R32/800g (28,2oz)	R410A/800g (28,2oz)	R410A/1100g (38,8oz)
Weight:				
Net:	39 kg (86 lbs)	45 kg (99 lbs)	39 kg (86 lbs)	45 kg (99 lbs)
Gross:	45 kg (99 lbs)	48 kg (106 lbs)	45 kg (99 lbs)	48 kg (106 lbs)
Carton box size:	850 x 390 x 572 mm 33,5 x 15,4 x 22,5 in	960 x 408 x 670 mm 37,8 x 16,1 x 26,4 in	793 x 360 x 555 mm 31,2 x 14,2 x 21,9 in	960 x 408 x 670 mm 37,8 x 16,1 x 26,4 in
Best efficiency flow rate:	2,35 M ³ /h (10 GPM)	3,3 M ³ /h (15 GPM)	2,35 M ³ /h (10 GPM)	3,3 M ³ /h (15 GPM)
Flow detector:	Flow switch		Flow switch	
Noise at 1 m:	54dB(A)	62dB(A)	54dB(A)	62dB(A)
Electrical	CE models		NA* models	
Input Supply:	220 V ~ 240 V, 50 Hz		240 V ± 5%, 60 Hz	
	5kW	7,5kW	5kW	7,5kW
Power input (max):	1,29 kW	1,91 kW	1,6 kW	2,3 kW
Rated Current¹:	3,9 A	5,49 A	5,27 A	6,32 A
Max Current¹:	6,07 A	8,67 A	7,5 A	9,6 A
Communication Supply:	10-12 Vdc, 80mA		10-12 Vdc, 80mA	
Performances	CE models		NA* models	
	5kW	7,5kW	5kW	7,5kW
Heating capacity²:	5,54 kW	7,52 kW	5,34 kW	7,6 kW
Power input:	0,89 kW	1,23 kW	1,14 kW	1,36 kW
COP:	6,21	6,13	4,7	5,69
Heating capacity³:	3,99 kW	5,63 kW	4,06 kW	5,92 kW
Power input:	0,87 kW	1,26 kW	1,08 kW	1,36 kW
COP:	4,59	4,48	3,76	4,36
Cooling Capacity⁴:	3,87 kW	6,24 kW	3,73 kW	6,16 kW
Power input:	1,2 kW	1,66 kW	1,37 kW	1,72 kW
EER:	3,21	3,76	2,7	3,58

Compatibility

in.temp is compatible with all in.ye and in.yt versions equipped with a RS-485 interface.

in.temp requires software core 61 revision 54 or higher to operate.

¹ Wires gauge and breaker size should be dimensioned according to the maximum current rating.

² Based on the following operating conditions: 24°C (75°F) Ambient air, 26°C (79°F) Water inlet.

³ Based on the following operating conditions: 15°C (59°F) Ambient air, 26°C (79°F) Water inlet.

⁴ Based on the following operating conditions: 35°C (95°F) Ambient air, 29°C (84°F) Water inlet.

*North American



9919-101640-A
Rev. 10-2019

© Groupe Gecko Alliance inc., 2019
All trademarks or registered trademarks
are the property of their respective owners.

Gecko Alliance
450 des Canetons, Québec (Qc), G2E 5W6 Canada, 1.800.78.GECKO
www.geckoalliance.com

Printed in Canada